



# μMETOS NB-IoT

## *Manual*



Pessl Instruments, GmbH

Version 2.0, 02-2022

## Content

<b>1. PURPOSE</b>	<b>3</b>
<b>2. REQUIREMENTS</b>	<b>3</b>
<b>3. TECHNICAL OVERVIEW</b>	<b>4</b>
<b>4. HOUSING</b>	<b>5</b>
4.1 OPENING THE HOUSING AND ACCESSING THE MOTHERBOARD	6
<b>5. <math>\mu</math>METOS NB-IOT QUICK START</b>	<b>7</b>
<b>6. <math>\mu</math>METOS NB-IOT (29-0409) MOTHERBOARD OVERVIEW</b>	<b>7</b>
6.1 INPUTS AND CONNECTORS	8
<b>7. SIM CARD AND POWER SYSTEM</b>	<b>10</b>
7.1 SIM CARD HANDLING	10
7.2 POWERING UP THE MOTHERBOARD	12
7.3 $\mu$ METOS NB-IOT MINIMUM POWER REQUIREMENTS	14
<b>8. SUPPORTED SENSORS</b>	<b>15</b>
<b>9. CONNECTING THE <math>\mu</math>METOS NB-IOT TO THE PC</b>	<b>16</b>
9.1. OPENING THE COM PORT AND ACCESSING MAIN MENU VIA TERATERM APP	17
<b>10. <math>\mu</math>METOS NB-IOT MENUS AND CONFIGURATION</b>	<b>20</b>
10.1 MENU OVERVIEW	20
10.2 STATION (SYSTEM) CONFIGURATION	27
10.3 SENSORS CONFIGURATION	28
10.4 MODEM CONFIGURATION	31
<b>11. <math>\mu</math>METOS NB-IOT COMMUNICATION CHECK</b>	<b>34</b>
<b>12. <math>\mu</math>METOS NB-IOT FIRMWARE</b>	<b>35</b>
<b>13. FIELDCLIMATE</b>	<b>35</b>
REGISTER ON THE FIELDCLIMATE	35
ADD YOUR $\mu$ METOS NB-IOT DEVICE TO YOUR FIELDCLIMATE PROFILE	36
<b>14. FIELDCLIMATE API</b>	<b>37</b>
<b>15. FAQ</b>	<b>37</b>
15.1. MODEM RESPONSES FOR JOINING THE MOBILE NETWORK	37
15.2. NO SIM CARD DETECTED	38
<b>16. SUPPORT</b>	<b>39</b>
<b>APPENDIX A: EXAMPLE OF SUCCESSFUL COMMUNICATION</b>	<b>40</b>
<b>APPENDIX B: EXAMPLE OF A FAILED GETTING GPS POSITION</b>	<b>45</b>
<b>APPENDIX C: EXAMPLE OF AN UNSUCCESSFUL COMMUNICATION</b>	<b>47</b>

μMETOS NB-IoT is an LPWAN weather station that transmits data over the LTE Cat M1 or LTE Cat NB1 mobile network, designed to monitor climate parameters (rain and temperature), soil characteristics (soil moisture, soil temperature and electrical conductivity), water pressure, multisensory SDI12 probes etc. everything what the standard user needs with possibility for further expansion. The version with the HL7802 modem also supports the 2G network connectivity fallback in case when the LPWAN network is not available.

Low cost, low power consumption, long range connectivity. Preset data is consistently measured in 15-minute intervals and sent every 60 minutes to the server - and this can be changed to fit the specific monitoring needs.

For mitigating connectivity issues, the station stores data of the last few days internally and resends the measured values to the cloud when the mobile network is again available. All the data is synchronized and stored on the FieldClimate platform, integrated with all additional services from Pessl Instruments and available for further integrations via PI API. It supports an external antenna option and it has a built-in GPS sensor.

Website: <https://metos.at/micrometos-nbiot/>

Technical catalog: <https://metos.at/publications/>

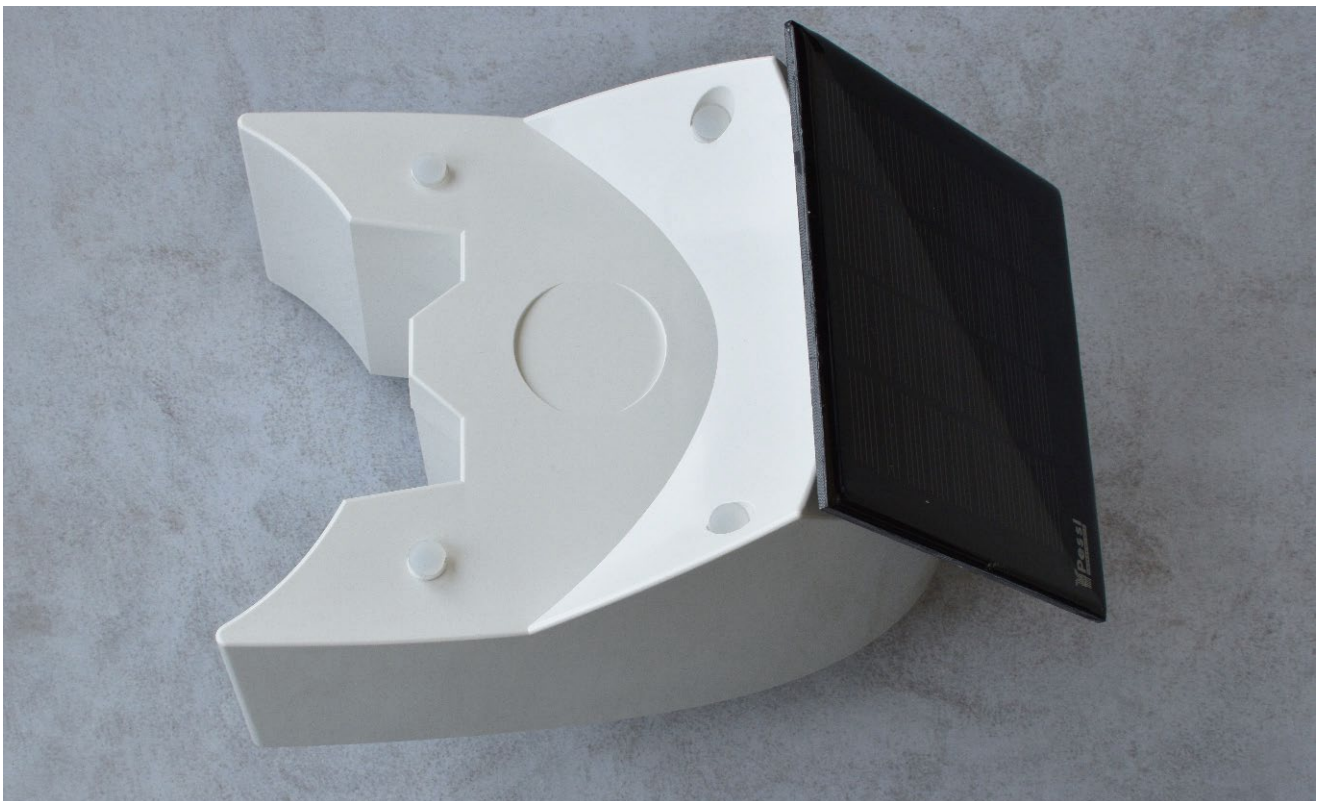

Picture 1 – Top view on the new μMETOS NB-IoT housing

## 1. Purpose

Here is a technical manual for the  $\mu$ METOS NB-IoT product. It contains the information on how to handle the product with emphasis on the configuration and connectivity.

For the quick overview of the product please refer to the  $\mu$ METOS NB-IoT short manual.

## 2. Requirements

For setting up the parameters, updating the firmware and observing the sensors and communication process, you need to connect the motherboard to the Windows OS PC using the micro-USB cable.

For connectivity you need to insert the micro-SIM card with NB-IoT or CatM1 connectivity data plan, optionally, SIM card with 2G fallback can be used as well.

The motherboard needs to be connected to the power system (6V battery and solar panel).

To open the housing, you need an Allen key.

## 3. Video manuals

In addition to the text manual, we are providing these video manuals (available on YouTube via direct link):



Opening the Housing

<https://bit.ly/3sl6xIW>



Take out Sim and Turn off battery

<https://bit.ly/3B4weBj>



Take housing off

<https://bit.ly/3L92rfz>



Configuration, sensors and connectivity check-up (Running test)

<https://bit.ly/3AZVGbe>



Insert Sim and Turn on battery

<https://bit.ly/3rxnGzZ>



Cleaning and maintenance

<https://bit.ly/3J9PmR8>

## 4. Technical overview

Technical specifications:

Housing	UV resistant polycarbonate plastic (Protection class IP65)
Connectivity	NB-IoT/CatM1: Category: Cat-M1/NB1 Frequency Band: B1, B2, B3, B4, B5, B8, B9, B10, B12, B13, B14, B17, B18, B19, B20, B25, B26, B27, B28, B66 with 2G fallback
Battery	6V charging battery
Solar panel	Dimensions: 13.5 x 13.5 cm, 1,5 Watt solar panel
Dimensions	24.4 cm L x 16.1 cm W x 18.2 cm H
Weight	1.6 kg
Dimensions with rain gauge	37.7 cm L x 17.1 cm W x 18.3 cm H
Weight with rain gauge	2.25 kg

Modem details and certifications:

<https://www.sierrawireless.com/iot-solutions/products/hl7802/>

## 5. Housing

Dimensions without rain gauge:

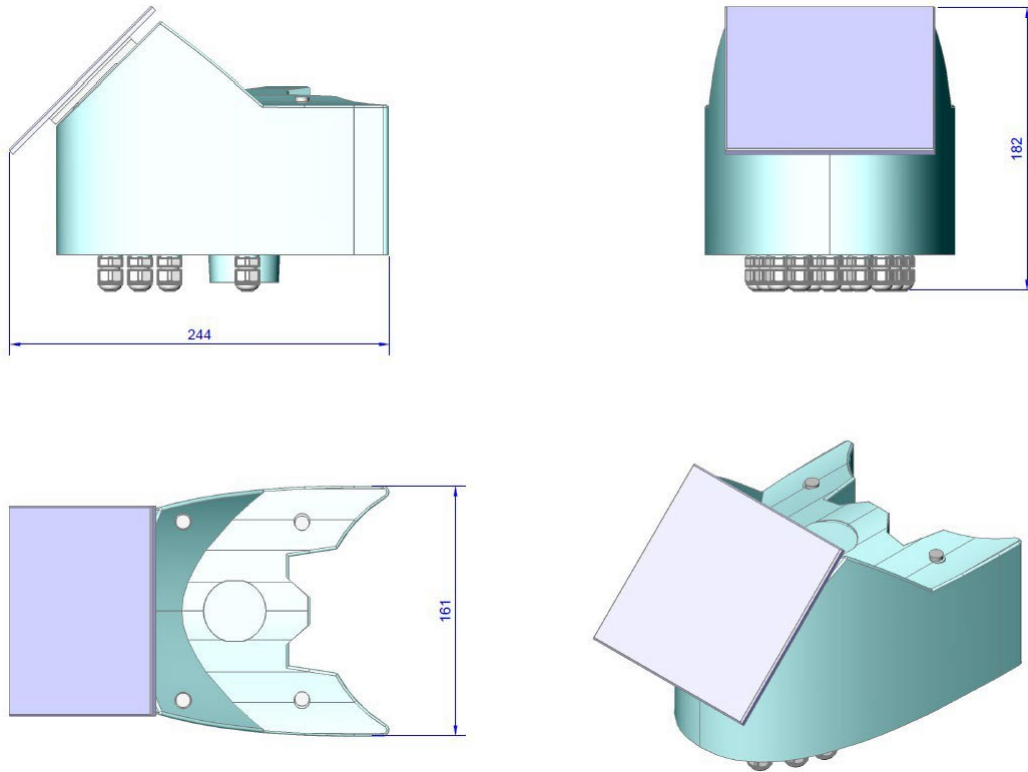

Dimensions with rain gauge:

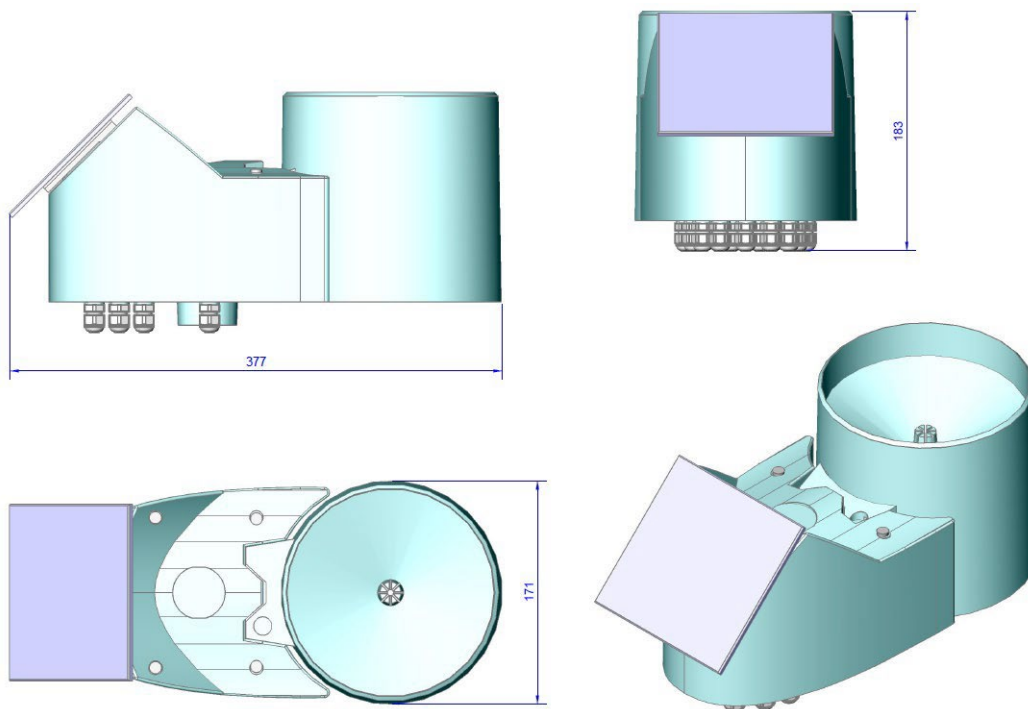

## 5.1 Opening the housing and accessing the motherboard

Exploded view:

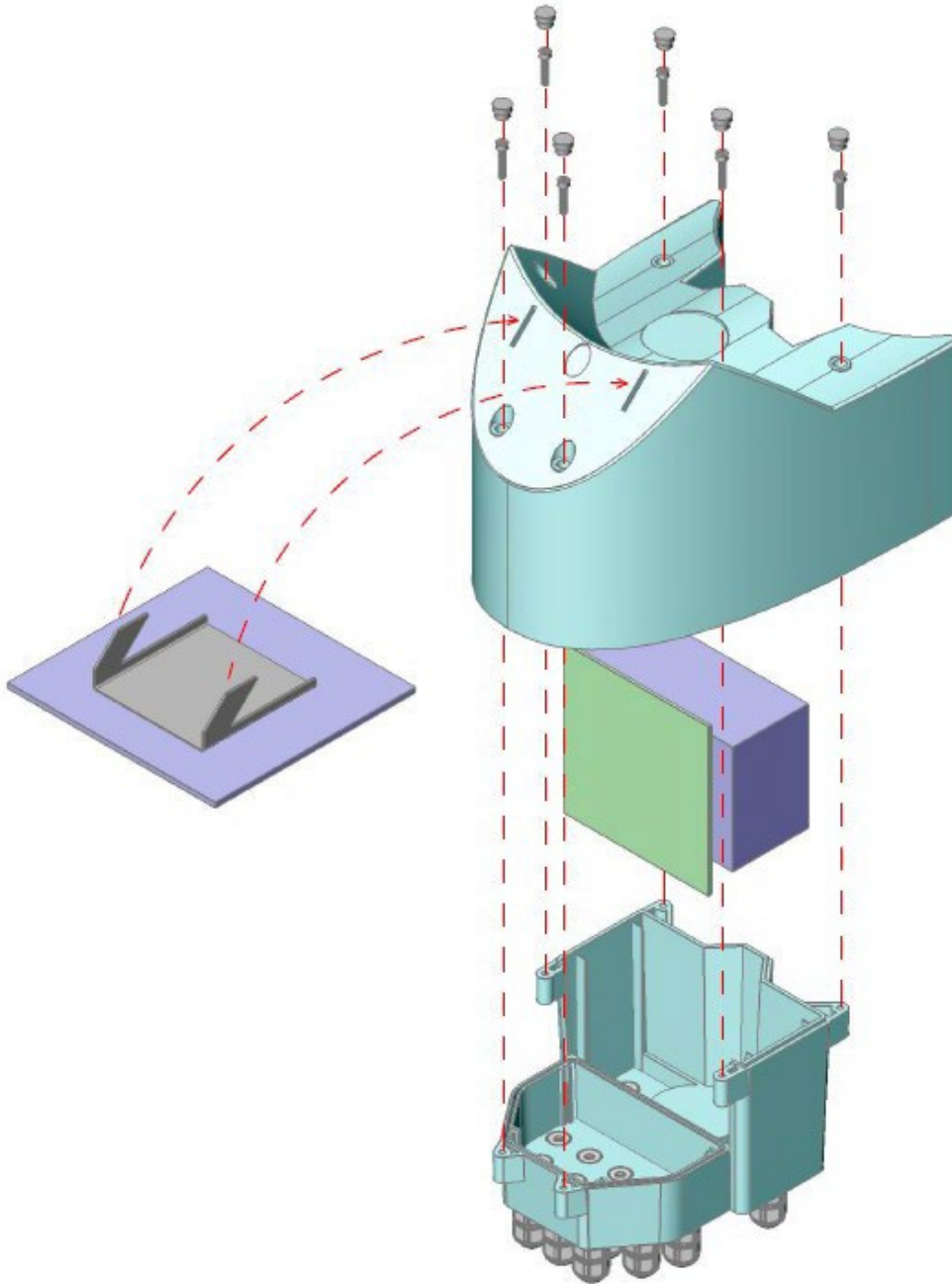

Steps:

1. remove the solar panel
2. remove the rubber water protectors
3. use Allen key to unscrew the 6 screws
4. hold the internal part and gently pull the top cover part upward

## 6. $\mu$ METOS NB-IoT quick start

To start up the  $\mu$ METOS NB-IoT:

1. insert the SIM card
2. connect the power supply (battery and solar panel)
3. check data on the FieldClimate

All steps are described in detail in this document.

It is recommended to check out the product short manual: <https://bit.ly/38vQWzV>.

## 7. $\mu$ METOS NB-IoT (29-0409) motherboard overview

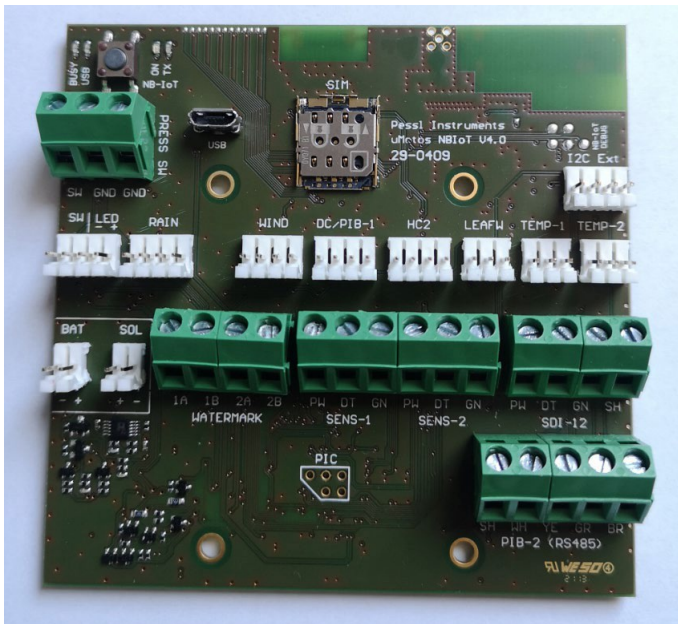

Picture 2 - Front side of the  $\mu$ METOS NB-IoT motherboard

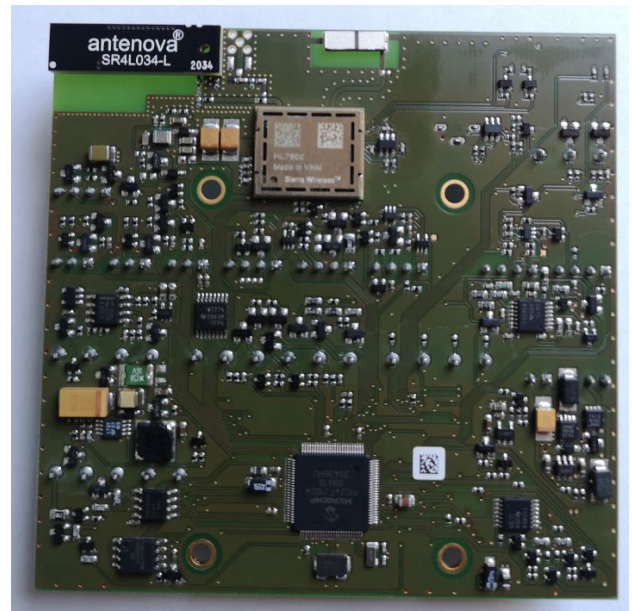

Picture 3 - Front side of the  $\mu$ METOS NB-IoT motherboard



## 7.1 Inputs and connectors

Front side:

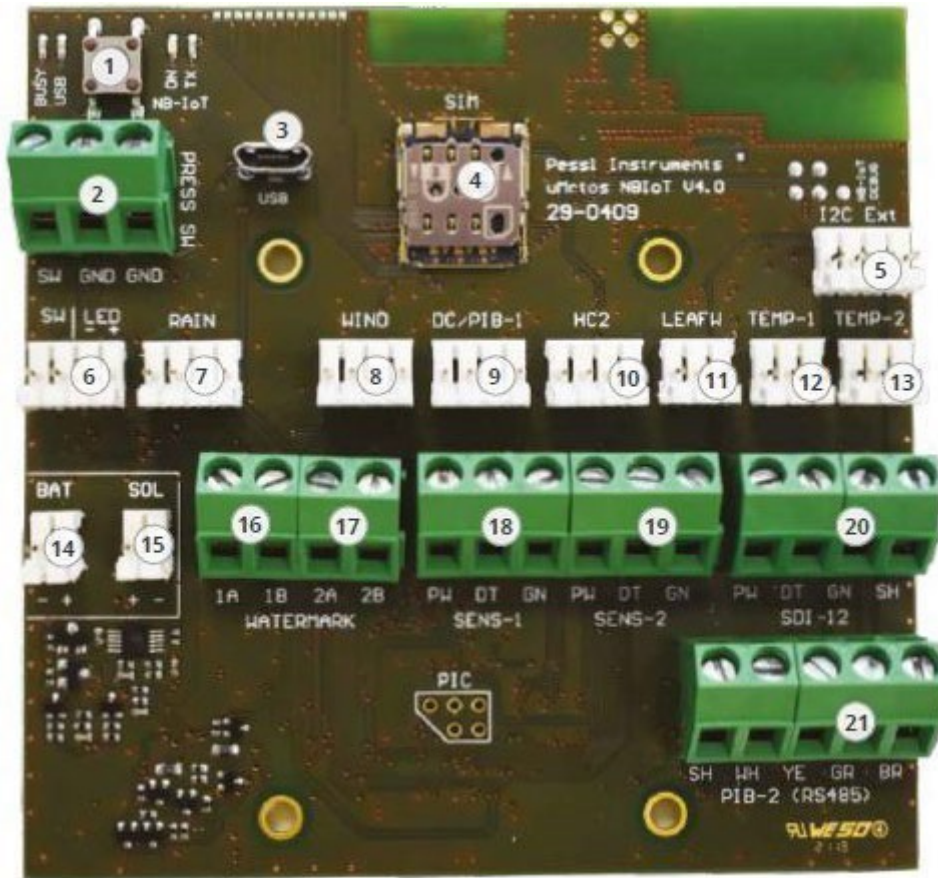

Picture 4 - Front side of the μMETOS NB-IoT motherboard (29-0409) with labeled elements

Number	Label	Description
1		internal connectivity test button
2	PRESS SW	Pressure switch input
3	USB	Micro-B USB port
4	SIM	Micro SIM card slot
5	I2C Ext	I2C Extension port input
6	SW   LED	External button with LED status connector
7	RAIN	Rain gauge or Water meter sensor input
8	WIND	Anemometer or Counter sensor input
9	DC/PIB-1	DC (duty cycle) for Pyranometer sensor input or PI-Bus sensor input
10	HC2	Hygroclip sensor input
11	LEAFW	Leaf wetness sensor input
12	TEMP-1	(DS18B20) - dedicated soil temperature sensor input
13	TEMP-2	(DS18B20) - dedicated air temperature sensor input
14	BAT	6V battery connector
15	SOL	Solar panel connector
16	WATERMARK 1A 1B	1 <sup>st</sup> watermark sensor input
17	WATERMARK 2A 2B	2 <sup>nd</sup> watermark sensor input
18	SENS-1	Decagon/METER Group sensor / PI-Bus sensor input

19	SENS-2	Decagon/METER Group sensor / PI-Bus sensor input
20	SDI-12	SDI12 sensor input
21	PIB-2 (RS485)	General PI sensor bus input

Back side:

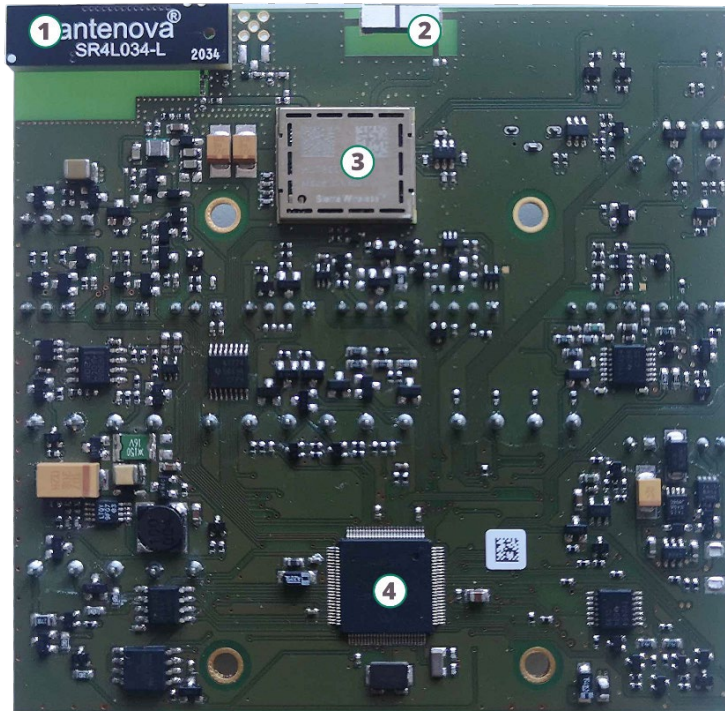

Picture 5 - Back side of the μMETOS NB-IoT motherboard (29-0409) with labeled elements

Number	Label	Description
1		Onboard LTE-M antenna
2		GPS antenna
3		HL7802 modem
4		PIC24FJ1024 microcontroller

## 8. SIM card and power system

### 8.1 SIM card handling

μMETOS NB-IoT product uses micro (3FF) SIM cards for mobile connectivity.

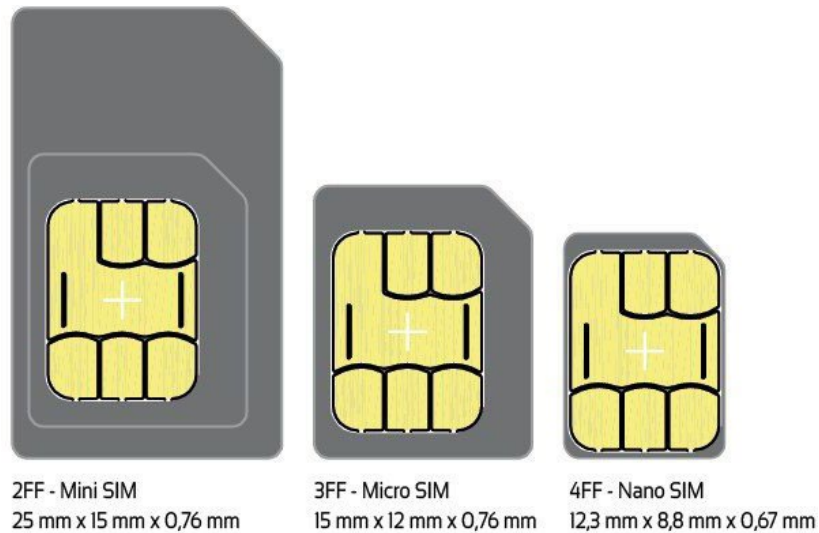

Picture 6 – SIM card form factor sizes

#### Inserting the SIM card:

1. make sure that the battery and the solar panel are disconnected from the motherboard

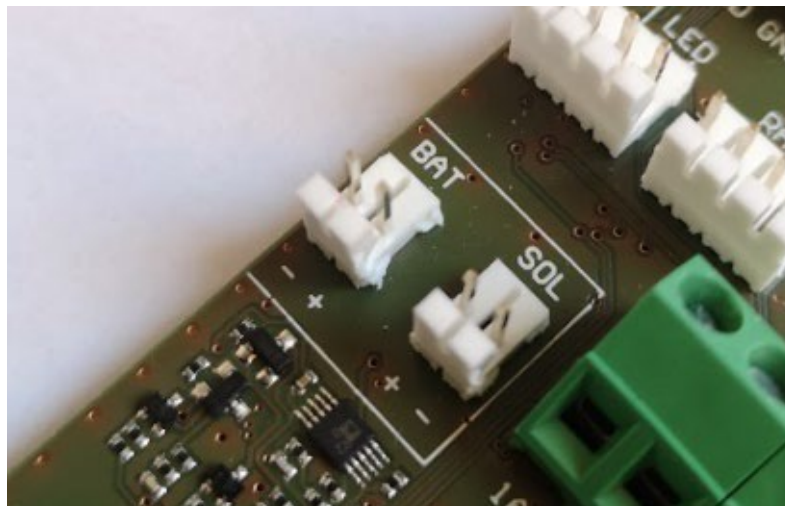

Picture 7 – Disconnected power sources

2. gently push the SIM card holder toward the “SIM” label to unlock the holder

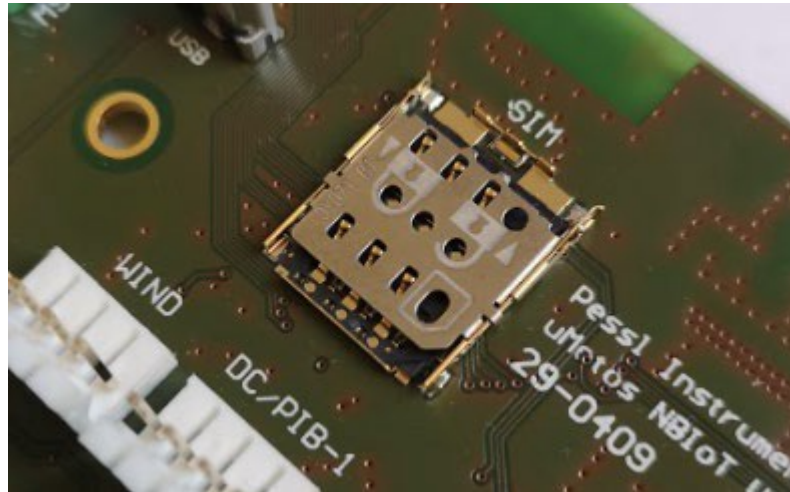

Picture 8 – SIM card holder in a locked state

3. open the holder

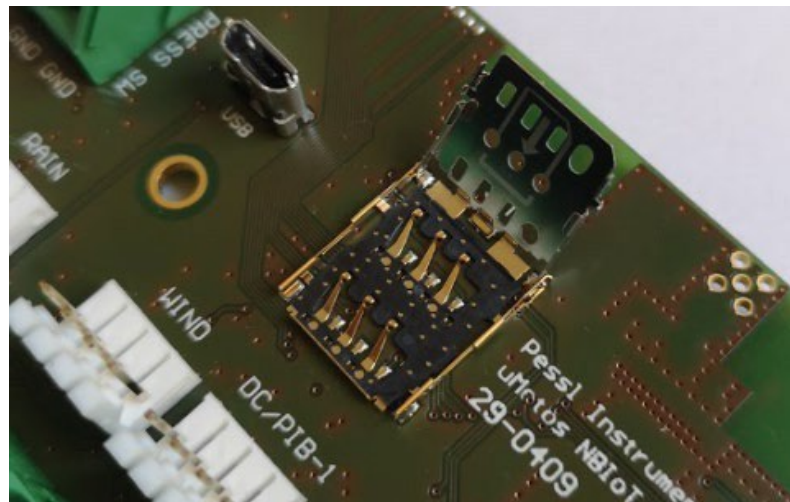

Picture 9 – Opened SIM card holder

4. insert the SIM card, make sure the SIM card is oriented correctly



Picture 2 – Inserted SIM card with correct orientation

5. gently press down the holder with the inserted SIM card

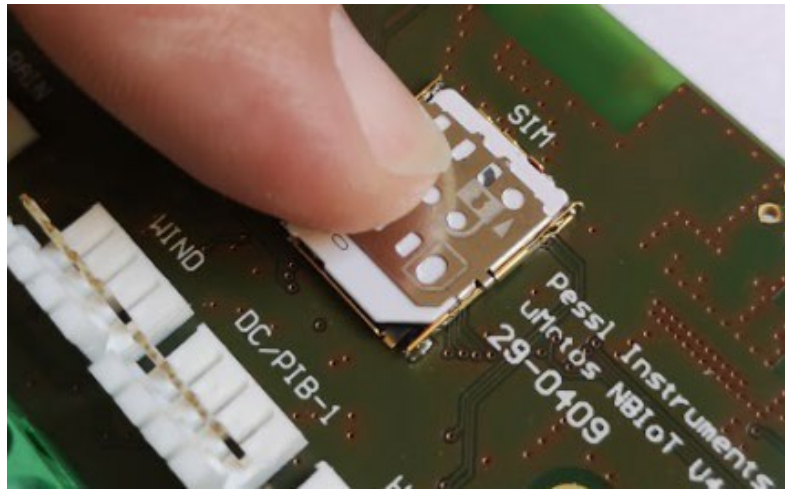

Picture 10 – Closed sim card holder

6. slide the holder back down into lock position

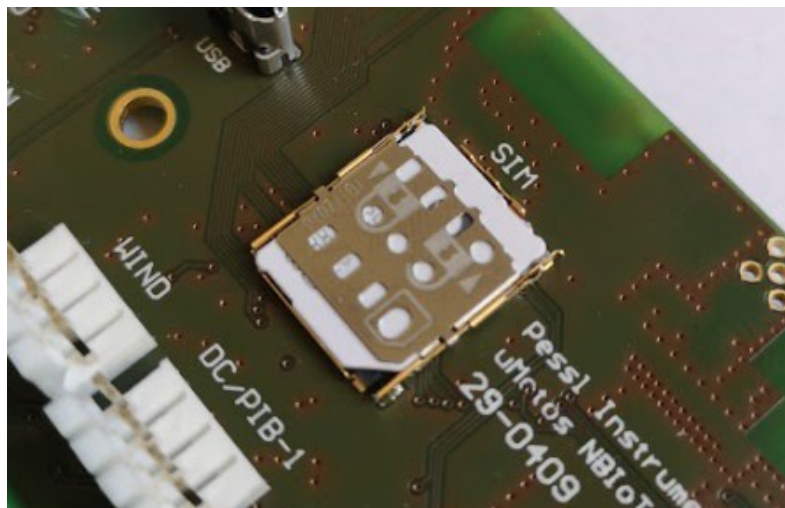

Picture 11 – Correctly inserted SIM card with locked holder

**Be very careful:** if you apply too much force and if you close the holder when it is not in a completely open state, you will bend the metallic pivots and the SIM card holder will no longer provide a good SIM card connection – subsequently the communication will fail and you will end up with a damaged motherboard which will need to be replaced.

## 8.2 Powering up the motherboard

μMETOS NB-IoT weather station needs power from the 6V battery which is recharged from the solar panel.

Power up sequence:

1. connect the battery to the BAT connector, make sure the polarity is correct, negative (-) is on the left side and positive (+) terminal is on the right side for the battery connector
2. connect the solar panel to the SOL connector, make sure the polarity is correct, negative (-) is on the right side and positive (+) terminal is on the left side for the solar connector

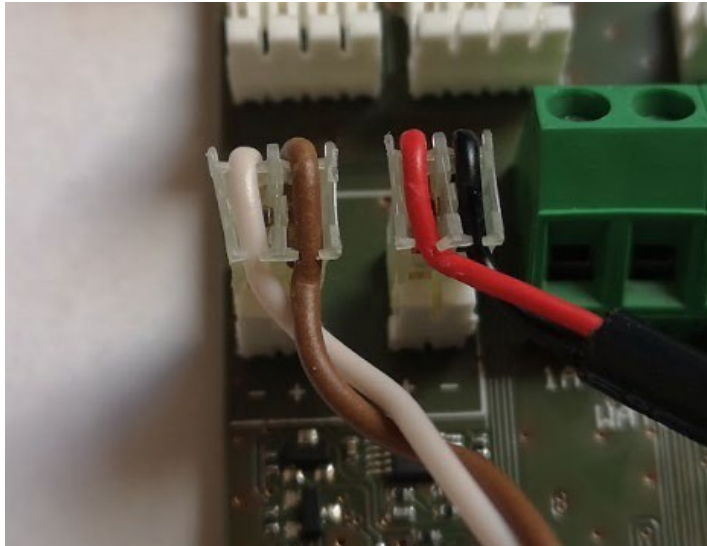

Picture 12 – Power inputs labeled polarity on the board



Picture 13 – Left: Battery cable, right: solar panel cable

Common color scheme:

Battery cable:

- WHITE cable is negative (-), connected to the – battery terminal
- BROWN cable is positive (+), connected to the + battery terminal

Solar panel cable:

RED cable is positive (+)

BLACK cable is negative (-)

**Be very careful:** if you connect the wrong power source to a wrong power input or if you reverse the polarity on any power input the motherboard can have issues and possible burnout. In such a case, the motherboard will have to be replaced.

### 7.3 $\mu$ METOS NB-IoT minimum power requirements

$\mu$ METOS NB-IoT product has 3 different states which are defined by the battery voltage:

Stage	Minimum voltage	Sensor measurements	Data transmissions	Note
1. Default mode	> 6V	✓	✓	default (normal) operating mode where the device measures and logs sensors data and transmits the logs to the FieldClimate cloud
2. Measure mode	5.8 V – 6 V	✓	✗	device is only measuring and logging sensors data, it does not have enough power to execute transmission
3. Sleep mode	< 5.8 V	✗	✗	device does not have enough power to measure the sensors or to do the data transmissions

$\mu$ METOS NB-IoT is automatically handling the modes. When the battery power is not sufficient it goes from high to low power mode (1 to 3) and when the battery is sufficiently charged again it transitions from low (3) to default (1) power mode.

When the  $\mu$ METOS NB-IoT is in Measure mode (2) it stores the measured data in the internal memory. After the station has sufficient power for transmission, it transmits all old stored data from the internal memory to the FieldClimate cloud.

Usual battery voltage with solar panel ranges between 6.2 up to 6.6 V.

## 8. Supported sensors

List of supported sensors can be found here:

[https://docs.google.com/spreadsheets/d/1Gyod8t-NwcGlnMAxL3yPAA0num0nTvotipwJT\\_T4NfU/edit?usp=sharing](https://docs.google.com/spreadsheets/d/1Gyod8t-NwcGlnMAxL3yPAA0num0nTvotipwJT_T4NfU/edit?usp=sharing)

On the bottom select the  $\mu$ METOS NB-IoT (31) tab:

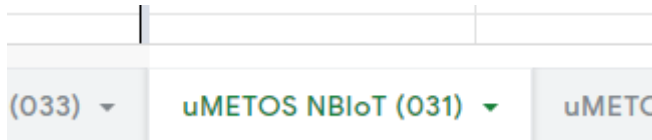

and on the top side look for the board number 29-0409:

	A	B	C	D	E	F
1				29-0409		
2	Sensor:	Sensor code:	Sensor order (pricelist) name:	Input:	Supported in FW:	Note:
3	Air temperature [C]	0x00				
4	Relative humidity [%]	0x01				
5	Solar radiation [W/mm]	0x02	IM506D	DC/PIB-1	v3.00	
6	Brightness [Min]	0x03				
7	Leaf Wetness [Min]	0x04	IM521CD			
8	Wind speed [m/s]	0x05				
9	Precipitation [mm]	0x06	IM523	RAIN	v3.00	

In the table you can see which sensors are supported, on which input they should be connected to and which is the minimum required  $\mu$ METOS NB-IoT firmware version.

Example: in the table we can see that the Solar radiation sensor needs to be connected to the DC/PIB-1 sensor input and that the motherboard needs to be programmed with minimum 3.00 firmware version.



## 9. Connecting the $\mu$ METOS NB-IoT to the PC

Connecting the  $\mu$ METOS NB-IoT to the PC steps:

1. make sure the power (battery and the solar panel) is connected to the motherboard
2. connect the micro USB cable to the motherboard and USB port of your pc

After the USB cable is connected the USB LED status will turn on with orange color.



Picture 14 – USB LED status: orange when the USB is connected

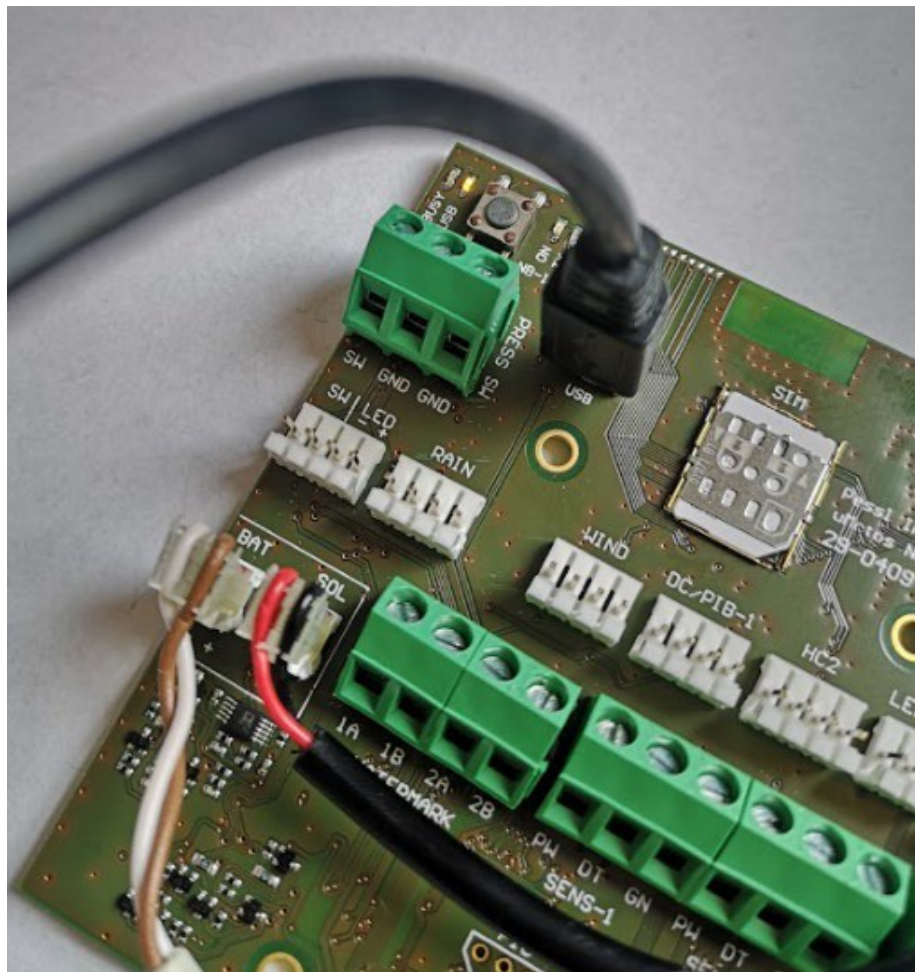

Picture 15 – Connected power, inserted SIM card and connected USB cable

## 9.1. Opening the COM port and accessing main menu via TeraTerm app

After the motherboard is connected to the PC, it will automatically recognize the device and install appropriate USB drivers. If drivers are not recognized, update your Windows OS.

### Optional step:

You can open up the Device manager and check which USB COM port assigned to the  $\mu$ METOS NB-IoT. In this example, we can see the Windows OS assigned COM5 to the device:

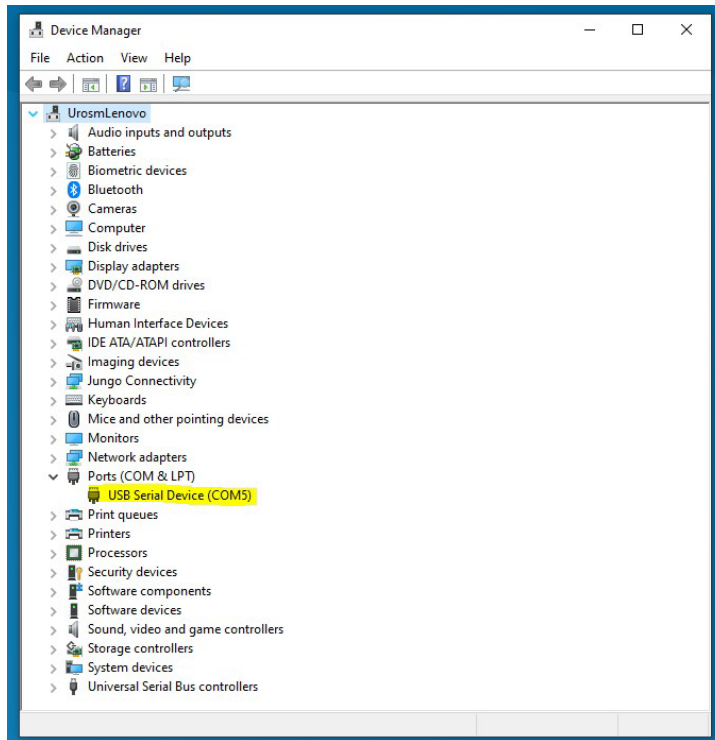

Picture 16 – Checking assigned COM port in Device manager

For accessing the settings, logs... on the  $\mu$ METOS NB-IoT weather station we recommend that you use free TeraTerm terminal app. You can download it from here: <https://osdn.net/projects/ttssh2/releases/>

Steps:

1. Run the TeraTerm app and select the appropriate COM port.

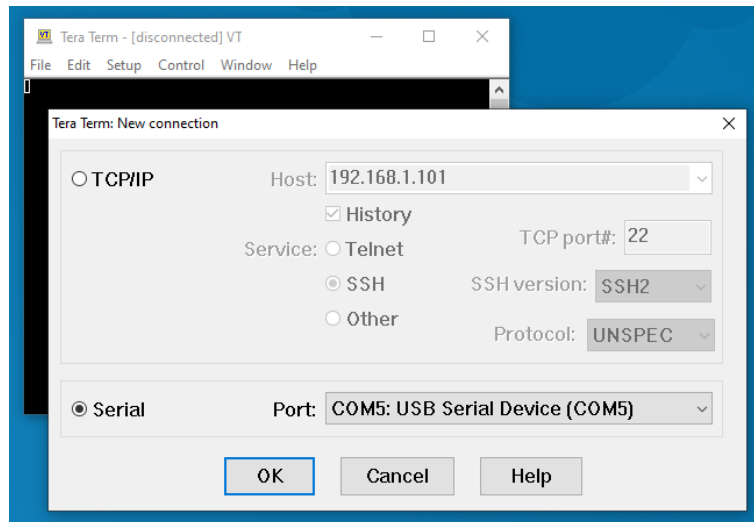

Picture 17 – Select Serial and appropriate COM port

2. Go in Setup > Terminal and select CR+LF in Transmit dropdown list and click OK

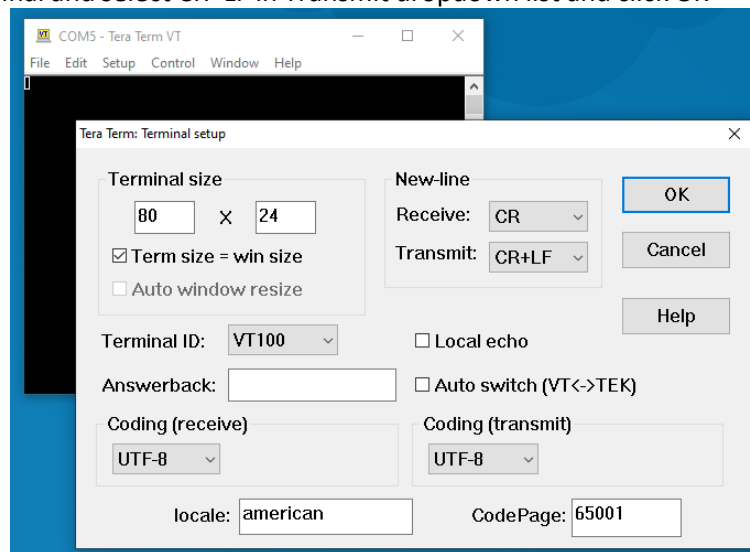

Picture 18 – Set up CR+LF for Transmit

3. Press the key H and you will see the main menu

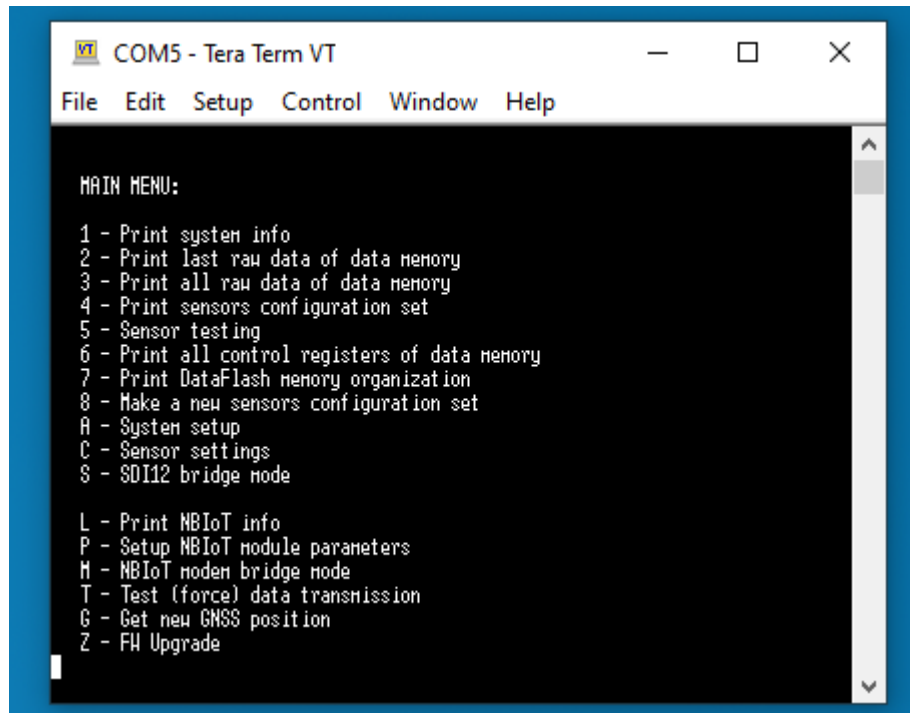

Picture 19 – Main menu

- For any debugging, logging etc. we recommend that you do a Log of all the messages that appear in the TeraTerm. This can be easily done with File > Log and Save.

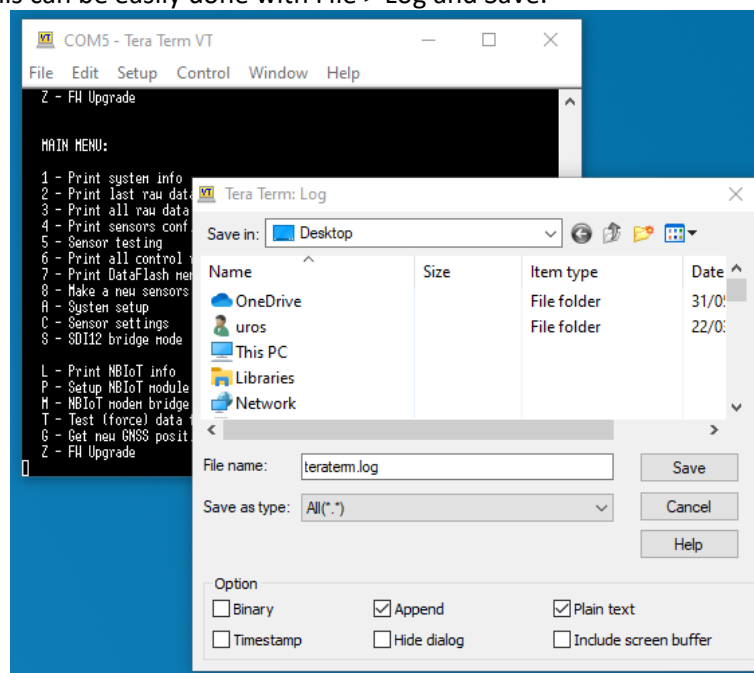

Picture 20 – Generating log file of all messages

## 10. $\mu$ METOS NB-IoT menus and configuration

The menu structure can differ from one firmware version to another in slight changes. In this manual we are describing the latest available firmware.

### 10.1 Menu overview

Press key **H** to see the main menu.

#### MAIN MENU:

- 1 - Print system info
- 2 - Print last raw data of data memory
- 3 - Print all raw data of data memory
- 4 - Print sensors configuration set
- 5 - Sensor testing
- 6 - Print all control registers of data memory
- 7 - Print DataFlash memory organization
- 8 - Make a new sensors configuration set
- A - System setup
- C - Sensor settings
- S - SDI12 bridge mode
  
- L - Print NB-IoT info
- P - Setup NB-IoT module parameters
- M - NB-IoT modem bridge mode
- T - Test (force) data transmission
- G - Get new GNSS position
- Z - FW Upgrade

#### Option 1 - Print system info:

Press key **1** to see the system info.

#### $\mu$ METOS NB-IoT - System info:

Hardware version:	v4.00
Hardware ID:	29-0409
Device ID:	49
Device type:	$\mu$ METOS NB-IoT

Firmware version: v3.00  
Firmware revision date: 2021-05-08 02:01:00  
Device description: µMETOS NB-IoT v4.0 Station  
Serial Number: 03C0CFC0  
Current date and time: 2000-01-01 00:12:54

Status of measurement: running  
Next alarm time: 00:15:00  
Measure interval [sec.]: 900  
Logging interval [sec.]: 900  
Transmission int. [sec.]: 3600  
Max. number of data packets: All

GNSS Data: None

NB-IoT stack version: v1.07  
NB-IoT stack revision date: 2021-04-30 17:30:00

USB stack version: v1.04  
USB stack revision date: 2020-10-13 11:52:00

Bootloader version: v1.03  
Bootloader revision date: 2020-04-15 15:49:00  
Bootloader description: BOOT24\_1024GB610

Press H for help.

## Option 2 - Print last raw data of data memory

Press key **2** to see the last raw data.

Last raw data records from DataFlash memory:

Ord.Nm.	RECORD HEADER	RAW SENSOR DATA VALUES
0000001	12 41 01 2000-01-01 00:00:00 00000001	19BC 1ADE

Press H for help.

### Option 3 - Print all raw data of data memory

Press key **3** to see all raw data.

All raw data records from DataFlash memory:

Ord.Nm.	RECORD HEADER	RAW SENSOR DATA VALUES
0000001	12 3A 01 2000-01-01 00:00:00 00000804	1B0C 0000
0000002	12 22 01 2021-05-20 10:15:00 00000011	1B08 0000
0000003	12 04 01 2021-05-20 10:30:00 00000010	1B0A 0000
0000004	12 42 01 2021-05-20 10:45:00 00000000	1B29 0000
0000005	12 41 01 2000-01-01 00:00:00 00000001	19BC 1ADE

Press H for help.

### Option 4 - Print sensors configuration set

Press key **4** to see connected sensors.

Sensors configuration set:

Chan.	S.Code	Full Name	Short	Unit	Size	LST	SUM	AVG	MIN	MAX
TIM	USE	AXL								
1	0x0007	Battery voltage	BATTR	mV	2	X				
2	0x001E	Solar Panel	SOLPN	mV	2	X				

Press H for help.

### Option 5 - Sensor testing

Press key **5** to measure all connected sensors and see sensor data.

Sensor testing:

Input	Full Name Of Sensor	Short	Value	Unit	Notes
BAT	Battery voltage	BATTR	6502	mV	
SOL	Solar Panel	SOLPN	6819	mV	

Note: Press 8 to save a new sensor configuration set.

Done.

Press H for help.

### Option 6 - Print all control registers of data memory

Press key **6** to see all control registers.

Control registers of data memory:

The number of all records = 5  
The number of last records = 1  
Pointer to initial record = 0  
Pointer to starting record = 4  
Pointer to next record = 5  
Pointer of Memory Ctrl. = 5  
Force data saving = FALSE

Size of SD record = 18  
Max. number of rec. ptrs = 234360  
Max. number of SD rec. = 234358  
Number of SD values = 2  
Number of 1k records = 0

Press H for help.

### Option 7 - Print DataFlash memory organization

Press key **7** to see station dataflash (memory) status.

DataFlash memory organization:

DataFlash memory size = 4325376  
Record Ctrl Reg. adr. = 3696  
Sensor Config. Set adr. = 3710  
Sensor Config. Set size = 564  
SD Record memory adr. = 6864  
SD Record memory size = 4218512



Events Rec. memory adr. = 4225376  
Events Rec. memory size = 100000  
SD Record (max. size) = 526

Press H for help.

### Option 8 - Make a new sensors configuration set

Press key **8** to detect and store all connected sensors to the motherboard. You need to confirm the new configuration with pressing key Y.

Do you really want to make a new sensors configuration set? [Y - Yes / N - No]

New sensors configuration set:  
AWS sensor config... restored!  
Static data rewritten!  
Done.

Press H for help.

### Option A - System setup

Press key **A** to enter the system setup menu. Further explained in paragraph 8.2.

SYSTEM SETUP MENU:

- 1 - Setup the measure/logging/transmission intervals -> 900/900/3600 sec.
- 2 - Setup the system date and time -> 2000-01-01 00:17:30
- 3 - Setup the max. number of data logged packets -> All

Press ESC to return to MAIN MENU.

### Option C - Sensor settings

Press key **C** to enter the sensors settings menu. Further explained in paragraph 8.3.

SENSOR SETTINGS:

- 1 - Sensor type on RAIN -> Rain Gauge
- 2 - Sensor resolution on RAIN -> 0.2 mm
- 3 - Sensor type on SENS-1 -> PI-BUS
- 4 - Sensor type on SENS-2 -> PI-BUS
- 5 - Soil media type -> Mineral soil

Press ESC to return to MAIN MENU.

### Option S - SDI12 bridge mode

Press key **S** when you want to enter direct bridge mode to the connected SDI12 sensor to execute any manual command directly on the sensor.

SDI12 interface - Bridge Mode.

Bridge mode opened (ESC - close):

Command:

Press Esc key to exit bridge mode.

### Option L - Print NBloT info

Press key **L** to see modem, SIM card, communication and server info.

NBIoT module - System info:

Server IP Address:	80.122.185.10
Server Remote Port:	33332
APN name:	None
Login:	None
Password:	None
Registration timeout:	240 sec.
Operator selection:	Automatic
Radio Access Technology:	NB1
Modem Model:	HL7802
Modem SW Version:	HL7802.4.6.8
Modem Revision ID:	HL7802.4.6.8.0
Modem Serial Number:	5N045586581410
IMEI:	354616091164660
SIM Card ID (ICCID):	8988239000123427554
IMSI:	901288003969214

Last connection status:

Signal Strength: 43 %  
Network type: roaming  
Network name: DATA ONLY  
Registration time: 88 sec.

Press H for help.

### Option P - Setup NBIoT module parameters

Press key **P** to set up any modem connectivity parameters. Further explained in paragraph 8.4.

SETUP THE NBIoT MODULE PARAMETERS:

1 - IP ADDRESS -> 80.122.185.10  
2 - REMOTE PORT -> 33332  
3 - APN NAME -> None  
4 - LOGIN -> None  
5 - PASSWORD -> None  
6 - REGISTRATION TIMEOUT -> 240 sec.  
7 - OPERATOR SELECTION -> Automatic  
8 - RADIO ACCESS TECHNOLOGY -> NB1  
D - Set the default parameters  
F - NBIoT FOTA  
U - NBIoT Module FW Upgrade

Press ESC to return to MAIN MENU.

### Option M - NBIoT modem bridge mode

Press key **M** to enter direct bridge mode to the HL7800 modem in order to execute any supported AT command directly on the modem.

NBIoT module - Bridge Mode.

NBIoT module power: ACTIVE  
NBIoT module booting... done.

Bridge mode opened (ESC - close):

Press Esc key to exit bridge mode.

## Option T - Test (force) data transmission

Press key T to start the communication process. Example of successful communication is in appendix A.

The initial communication (when the station is joining the CatM1 or NBloT mobile network for the first time) the registration can take up to 4 minutes. Average time necessary for first time registration is around 1.5 minute. All next communications are usually done in between 2 to 10 seconds.

## Option G - Get new GNSS position

Press key G to get a new GPS position. It can take up to 3 minutes. See output in Appendix B.

## Option Z - FW Upgrade

Press key Z in PI FW Uploader app if you want to manually reset the board into the bootloader mode. In the latest PI FW Uploader version 1.143 this is not needed anymore.

## 10.2 Station (system) configuration

SYSTEM SETUP MENU:

- 1 - Setup the measure/logging/transmission intervals -> 900/900/3600 sec.
- 2 - Setup the system date and time -> 2000-01-01 00:17:30
- 3 - Setup the max. number of data logged packets -> All

Press ESC to return to the MAIN MENU.

In this case the  $\mu$ METOS NB-IoT is set up to perform sensor measurements every 900 seconds (15 minutes), that it stores the measured data logs in 900 seconds (15 minutes) and that it transmits the stored data every 3600 seconds (every 1 hour).

### Option 1 - Setup the measure/logging/transmission intervals

We can change the measurement, logging and transmission interval values.

In this example, we set the measurement interval to 5 minutes, logging interval to 15 minutes and transmission interval to 30 minutes.

Set up the measure/logging interval:

Enter NEW MEASURE INTERVAL (900 sec.) [in seconds] (from 60 to 43200) = 300

Enter NEW LOGGING INTERVAL (900 sec.) [in seconds] (from 60 to 43200) = 900

Enter NEW TRANSMISSION INTERVAL (3600 sec.) [in seconds] (from 300 to 43200) = 1800

The new intervals changed!

Current status of intervals:

Measure interval [sec.]: 300

Logging interval [sec.]: 900

Transmission interval [sec.]: 1800

Press H for help.

Press ESC to return to MAIN MENU.

The same settings can be changed in the weather station configuration page in FieldClimate and they will be transmitted and applied on the station at the next transmission.

**Warning!** These settings have an effect on the battery and transmission data size.

The more frequent the measurements and the transmissions, the more battery power the device will need. The  $\mu$ METOS NB-IoT supports very frequent transmissions due to its rechargeable battery.

The same is true for the data transmissions. More frequent measurements and logging intervals will require more data to be transferred to the FieldClimate cloud. Make sure you have a suitable data plan with our SIM card.

### Option 2 - Setup the system date and time

There is no need to set up the system date and time as the values are synched automatically with each data transmission with FieldClimate cloud.

### Option 3 - Setup the max. number of data logged packets

Use this option when you want to send all logged data packets. It is not needed as the weather station automatically sends all the necessary packets.

Set up the max. number of data logged packets:

Current the max. number of packets: All

Do you want to send ALL logged data packets? [Y/N]

New max. number of data packets: All

Done.

Press H for help.

Press ESC to return to MAIN MENU.

## 10.3 Sensors configuration

$\mu$ METOS NB-IoT weather station supports defining the connected sensors on the RAIN, SENS-1 and SENS-2 inputs. It is mandatory to select the correct sensors from these menus in order for the station to recognize the sensors correctly.

This are the default settings which are used on the  $\mu$ METOS NB-IoT station:

SENSOR SETTINGS:

- 1 - Sensor type on RAIN -> Rain Gauge
- 2 - Sensor resolution on RAIN -> 0.2 mm
- 3 - Sensor type on SENS-1 -> PI-BUS
- 4 - Sensor type on SENS-2 -> PI-BUS
- 5 - Soil media type -> Mineral soil

Press ESC to return to MAIN MENU.

For all supported sensors see paragraph 8. Supported sensors.

### Option 1 - Sensor type on RAIN

Current sensor type on RAIN: Rain Gauge

- 0 - Rain Gauge
- 1 - Water Meter (Resettable)
- 2 - Water Meter (Accumulative)

Select new option: 0

New selected sensor type on RAIN: Rain Gauge

Done.

Press H for help.

Press ESC to return to MAIN MENU.

When you want to have a water meter sensor connected to the RAIN input we suggest that you select option 1 Water Meter (Resettable) value.

### Option 2 - Sensor resolution on RAIN

Current sensor resolution on RAIN: 0.2 mm

- 0 - 0.1 mm
- 1 - 0.2 mm
- 2 - 0.5 mm

Select new option: 1

New selected sensor resolution on RAIN: 0.2 mm

Done.

Press H for help.

Press ESC to return to MAIN MENU.

The default rain gauge tipping mechanism detects 0.2mm of rain for every tip. In case that you use some other rain gauge sensor, you can select between options 0.1, 0.2 and 0.5 mm of rain for each pulse from the sensor.

### Option 3 - Sensor type on SENS-1

Press ESC to return to MAIN MENU.

Current sensor type on SENS-1: PI-BUS

- 0 - PI-BUS
- 1 - Decagon/METER EC5
- 2 - Decagon/METER 10HS
- 3 - Decagon LEAF WETNESS
- 4 - METER PHYTOS 31
- 5 - Decagon MPS1
- 6 - Decagon MPS2
- 7 - Decagon MPS6
- 8 - METER TEROS 12
- 9 - Decagon/METER 5TE
- 10 - Decagon/METER 5TM
- 11 - Decagon/METER GS3
- 12 - Decagon/METER ES-2(F)
- 13 - Decagon/METER GS1
- 14 - METER CTD-10/HYDROS 21
- 15 - PI54D

Select new option: 0

New selected sensor type on SENS-1: PI-BUS

Done.

Press H for help.

Press ESC to return to MAIN MENU.

SENS-1 input on the  $\mu$ METOS NB-IoT board supports multiple different sensors. In the menu, the user needs to select the appropriate sensor, which is connected to the SENS-1 input otherwise the  $\mu$ METOS NB-IoT will use the default value of PIBUS sensor. When the user connects the PI54D sensor and does not select the option 15 – PI54D for this input, the  $\mu$ METOS NB-IoT will not recognize the connected sensor properly and the user will not get any values from this sensor on the FieldClimate platform.

After you insert the desired option press Enter key to confirm the input.

#### Option 4 - Sensor type on SENS-2

Same as for the Option 3 – Sensor type on SENS-1 but in this case the setting determines which sensor is connected on the SENS-2 input.

#### Option 5 - Soil media type

Default soil media type is set to 0 – Mineral soil as this option is used in the majority of cases. The user can select a different soil media type in the menu.

Current soil media type: Mineral soil

- 0 - Mineral soil
- 1 - Potting soil
- 2 - Rockwool soil
- 3 - Perlite soil
- 4 - Peat soil

Select new option: 0

New selected soil media type: Mineral soil

Done.

After you insert the desired option press Enter key to confirm the input.

## 10.4 Modem configuration

SETUP THE NBIOT MODULE PARAMETERS:

1 - IP ADDRESS -> 80.122.185.10



- 2 - REMOTE PORT -> 33332
- 3 - APN NAME -> None
- 4 - LOGIN -> None
- 5 - PASSWORD -> None
- 6 - REGISTRATION TIMEOUT -> 240 sec.
- 7 - OPERATOR SELECTION -> Automatic
- 8 - RADIO ACCESS TECHNOLOGY -> NB1
- D - Set the default parameters
- F - NB1oT FOTA
- U - NB1oT Module FW Upgrade

Press ESC to return to MAIN MENU.

### Option 1 - IP ADDRESS

This is the default IP address to which the station sends the data. This value should not be changed.

### Option 2 - REMOTE PORT

This is the default UDP port address to which the station sends the data. This value should not be changed.

### Option 3 - APN NAME

When the SIM card requires an APN to be set, the user needs to set appropriate APN value here.

### Option 4 - LOGIN

When the SIM card requires an APN username to be set, the user needs to set appropriate APN username value here.

### Option 5 - PASSWORD

When the SIM card requires an APN password to be set, the user needs to set appropriate APN password value here.

### Option 6 - REGISTRATION TIMEOUT

This is the maximum registration timeout where the weather station is trying to attach to the mobile network. The initial communication usually takes around 1.5 minute. All next communications are usually done in between 2 to 10 seconds. Setting the value higher to 240 seconds is not recommended.

### Option 7 - OPERATOR SELECTION

Current operator selection: Automatic

Do you want to select an operator manually? [Y/N]

Enter new numeric network name (MCC+MNC):

When the automatic mode is not sufficient, the user can insert a specific MCC and MNC mobile network operator code. After you enter the MCC and MNC value press Enter to confirm or press Esc to cancel and exit this menu.

### Option 8 - RADIO ACCESS TECHNOLOGY

Select new one or escape [ESC]:

- 1 - NB1

2 - CAT-M1

New radio access technology: NB1

Done.

Press H for help.

Press ESC to return to MAIN MENU.

User can select between two different RAT (Radio Access Technologies): NB1 or Cat-M1. The default value of the  $\mu$ METOS NB-IoT is to use the NB1 RAT.

### Option D - Set the default parameters

This option clears all user input configuration and sets the values back to default mode:

SETUP THE NBIOT MODULE PARAMETERS:

1 - IP ADDRESS -> 80.122.185.10

2 - REMOTE PORT -> 33332

3 - APN NAME -> None

4 - LOGIN -> None

5 - PASSWORD -> None

6 - REGISTRATION TIMEOUT -> 240 sec.

7 - OPERATOR SELECTION -> Automatic

8 - RADIO ACCESS TECHNOLOGY -> NB1

D - Set the default parameters

F - NBIoT FOTA

U - NBIoT Module FW Upgrade

### Option F - NBIoT FOTA

Option to update the firmware remotely. Some modes (NBIoT) are currently not supported.

### Option U - NBIoT Module FW Upgrade

Updating the HL7802 modem with a step-by-step guide in the terminal:

NBIoT MODEM FW UPDATE MODE

NB-IoT module booting up... waiting... done.

1. Disconnect COM port in Terminal Application.

2. Open the Sierra Updater Application and proceed with the instructions.

(Select UART port, enter COM port number and baud rate 115200)

3. Wait until the RED LED diode will be turned off indicating the end of the FW upload process.

!!! CAUTION: DON'T INTERRUPT FW UPLOADING PROCESS. AN INTERRUPTION CAN CAUSE FW CORRUPTION !!!

Press ESC or continue in the modem FW process according to previous instructions.

Use this only when instructed by our support or recommended on our website.

## 11. $\mu$ METOS NB-IoT communication check

Option L – Print NB-IoT info in the main menu will show you all communication parameters used for connectivity and it will print out the modem info and SIM card info.

Example:

NB-IoT module - System info:

```
Server IP Address:      80.122.185.10
Server Remote Port:    33332
APN name:              None
Login:                 None
Password:              None
Registration timeout:   240 sec.
Operator selection:    Automatic
Radio Access Technology: NB1

Modem Model:           HL7802
Modem SW Version:      HL7802.4.6.8
Modem Revision ID:     HL7802.4.6.8.0
Modem Serial Number:   5N045586581410
IMEI:                  354616091164660
SIM Card ID (ICCID):   89882390000123427554
IMSI:                  901288003969214
```

Last connection status:

Signal Strength:	41 %
Network type:	roaming
Network name:	DATA ONLY
Registration time:	10 sec.

Press H for help.

The last connection status tells us the signal strength (41%) of the NB-IoT (Radio Access Technology: NB1) connectivity, that the sim card is in the roaming network, it uses network with name “DATA ONLY” and it took 10 seconds for the last registration time to the network.

Example of a full successful communication is in Appendix A: Example of successful communication.

Example of failed communication is in Appendix C.

## 12. $\mu$ METOS NB-IoT firmware

The latest production firmware for the  $\mu$ METOS NB-IoT can be found here:

<https://drive.google.com/drive/folders/1ZF0b-vk2wb9zDSRrxUswbdhYueQnNhWp?usp=sharing>

in folder:

Production FW + Bootloaders >  $\mu$ METOS >  $\mu$ METOS LTE-M >  $\mu$ METOS NB-IoT (29-0409) > Firmware

## 13. FieldClimate

### Register on the FieldClimate

To start using services we provide, you need to register on the FieldClimate platform, which gives you access to the data in graphs and tables. FieldClimate also provides a powerful decision support system for growing your crops (plant protection, irrigation, sowing, harvesting, fertilizing).

Register as a new user on <http://ng.fieldclimate.com/> :

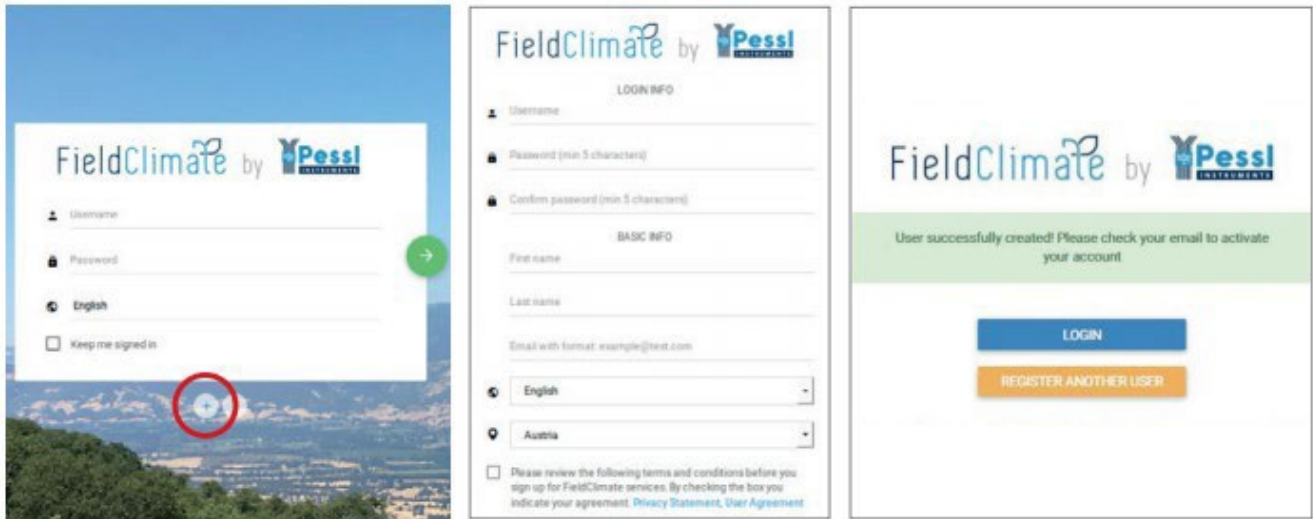

1. Go to [ng.fieldclimate.com/](https://ng.fieldclimate.com/) and click the button **data & e-mail**.
2. Insert your personal data and e-mail.
3. Check your e-mail and click on the link to activate the user account you created.

### Add your $\mu$ METOS NB-IoT device to your FieldClimate profile

Now you can login to [ng.FieldClimate.com](https://ng.FieldClimate.com). To add your  $\mu$ METOS device, click on the icon in the top right corner User Menu > Add/Remove station. It will ask you for the Station Serial number (SN) and the station key. Now the silver sticker (in the figure) which came with your  $\mu$ METOS has to be used. Key 1 gives you full (admin) access and enables you to change all the settings and set up the  $\mu$ METOS. With Key 2 the user is not allowed to change the station parameters, but can access all the data.

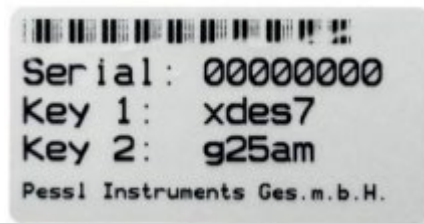

Picture 3 – Example of the label on the  $\mu$ METOS NB-IoT device

## Add Station ✕

Use the Station ID and key that came with your iMetos station to add it to your list. Use key 1 if you want to be able to change station configuration settings or key 2 if you want read-only access.

Station id:

Station key:

ADD STATION
DELETE STATION

Picture 21 – Screenshot of adding the device to your FieldClimate account

## 14. FieldClimate API

All the data which is available on the FieldClimate platform can be retrieved automatically via our FieldClimate API system. Latest documentation is here: <https://api.fieldclimate.com/v2/docs> .

## 15. FAQ

### 15.1. Modem responses for joining the mobile network

When the  $\mu$ METOS NB-IoT tries to join the mobile network, it responds with one of these responses:

<b>&lt;stat&gt;</b>	Indicates the EPS registration status
0	Not registered; MT is currently not searching for an operator to register to
1	Registered, home network
2	Not registered but MT is currently trying to attach or searching for an operator to register to
3	Registration denied
4	Unknown (e.g. out of E-UTRAN coverage)
5	Registered, roaming
6	Registered for "SMS only", home network (not applicable)
7	Registered for "SMS only", roaming (not applicable)
8	Attached for emergency bearer services only
9	Registered for "CSFB not preferred", home network (not applicable)
10	Registered for "CSFB not preferred", roaming (not applicable)

### Example 1:

```
AT+CEREG?  
+CEREG: 0,3  
OK
```

Means the station registration to the mobile network is denied. In this case, check the APN settings.

### Example 2:

```
AT+CEREG?  
+CEREG: 0,2  
OK
```

Means that the station is trying to find a network to register to.

### Example 3:

```
AT+CEREG?  
+CEREG: 0,1  
OK
```

The station successfully joined the home mobile network.

### Example 4:

```
AT+CEREG?  
+CEREG: 0,5  
OK
```

The station successfully joined the roaming mobile network.

More tech details on the commands and responses:

[https://source.sierrawireless.com/resources/airprime/software/airprime\\_hl78xx\\_at\\_commands\\_interface\\_guide/#sthash.pvbLGKlt.dpbs](https://source.sierrawireless.com/resources/airprime/software/airprime_hl78xx_at_commands_interface_guide/#sthash.pvbLGKlt.dpbs)

## 15.2. No SIM card detected

Check if the SIM card is inserted properly in the SIM card holder and if the holder is locked in the position. Unlocked holder or damaged (bent) pivots can lead to bad SIM card contact with the motherboard and the communication will fail.

## 16. Support

For all support questions, please send an email to [support@metos.at](mailto:support@metos.at) or contact your local key account manager or distributor.

When contacting support, it is very helpful that you provide us your description of the issue and the log from the Teraterm which includes output from Main menu options:

- 1 - Print system info
- 2 - Print last raw data of data memory
- 3 - Print all raw data of data memory
- 4 - Print sensors configuration set
- 5 - Sensor testing
- 6 - Print all control registers of data memory
- 7 - Print DataFlash memory organization
- A - System setup
- C - Sensor settings
- L - Print NBloT info
- P - Setup NBloT module parameters
- T - Test (force) data transmission

When remote support is needed, we can provide it via the TeamViewer app. In this case you need to connect the station to the PC and have working access to the TeraTerm main menu.



## Appendix A: Example of successful communication

FORCED DATA TRANSMISSION

SENSOR MEASUREMENT.

Done.

SENSOR DATA LOGGING.

Done.

NB IoT module power: ACTIVE

NB IoT module booting... done.

AT

OK

AT+CFUN?

+CFUN: 0

OK

AT+CFUN?

+CFUN: 0

OK

AT+CFUN?

+CFUN: 1

OK

AT+KSIMSEL?

+KSIMSEL: 0,,1

OK

AT&K3

OK

ATS2=255

OK

ATI0

HL7800

OK

ATI8

HL7802.4.6.8

OK

ATI3

HL7802.4.6.8.0

OK

AT+GSN

354616091164660

OK

AT+KGSN=3

+KGSN: 5N045586581410

OK

AT+CCID

+CCID: 89882390000123427554

OK

AT+CIMI

901288003969214

OK

AT+KSRAT?

+KSRAT: 1

OK

<<< NB1 network selected >>>

AT+CGDCONT?

+CGDCONT: 1,"IP",,,0,0,0,0,,0,,,,,

OK

AT+COPS?

+COPS: 0

OK

AT+CEREG?

+CEREG: 0,2

OK

AT+CEREG?

+CEREG: 0,2

OK

AT+CEREG?

+CEREG: 0,2

OK

AT+CEREG?

+CEREG: 0,2

OK

AT+CEREG?

+CEREG: 0,2

OK

AT+CEREG?

+CEREG: 0,2

OK

AT+CEREG?

+CEREG: 0,2

OK

AT+CEREG?

+CEREG: 0,5

OK

<<< Registered in 8 seconds, roaming >>>

AT+COPS?

+COPS: 0,0,"DATA ONLY",9

OK

AT+CGDCONT?

+CGDCONT: 1,"IP",,,0,0,0,0,0,,0,,,,,

OK

AT+CGPADDR=1

+CGPADDR: 1, "100.93.232.87"

OK

AT+KCNXCFG=1, "GPRS", ""

OK

AT+KCNXUP=1

OK

+KCNX\_IND: 1,1,0

AT+KUDPCFG=1,0

+KUDPCFG: 1

OK

+KUDP\_IND: 1,1

<<< Joined >>>

AT+KUDPSND=1, "80.122.185.10", "33332", 336

CONNECT

uY8CAgABwM/AAzEAAZABAIwBBCsFIQUIAAECEAURREFUQSBPTkxZABIIABQGAAAFXaTAWAWAQZOb251AAdOb251AA  
h0b251AAkBCkhMNzgwMAALSEw30DAwLjQuNi44AAxITDc4MDAuNC42LjguMAANMzU0NjE2MDkxMTY0NjYwAA440Tg4  
MjM5MDAwMDEyMzQyNzU1NAAPOTaxMjg4MDAzOTY5MjE0ABNnABcAAAAAGIQDGYQDGHhAOG/AAHDVOMDQ1NTg2NTgxND  
EwAB0yOS0wNDA5AA==

Ic8DAgEBwM/AAzEAIQYBABUREQAAAAcAAWMZHgACqxo=

--EOF--Pattern--

OK

+KUDP\_DATA: 1,40

AT+KUDPRCV=1,40

CONNECT

OW4CAAHAz8ADASEGASiHEQKEAwWEAwMQDgbwAA==--EOF--Pattern--

OK

+KUDP\_RCV: "80.122.185.10", 33332

<<< RESPONSE OK (SETTING PACKET) >>>

<<< CLOSING MODE >>>

AT+KUDPCLOSE=1

OK

AT+KCNXDOWN=1,1

OK

+KCNX\_IND: 1,3

AT+KSRAT?

+KSRAT: 1

OK

AT+CESQ

+CESQ: 99,99,255,255,28,43

OK

<<< Module Power OFF process >>>

AT

OK

AT+CPOF

OK

NB IoT module power: SLEEP

NEW REMOTE SETTINGS FROM SERVER RESPONSE

Measure interval: 15 min. (accepted)

Logging interval: 15 min. (accepted)

Transmission interval: 60 min. (accepted)

Network registration timeout: 240 sec. (accepted)

New timestamp: 2021-06-01 11:21:22 (accepted)

RTC upgraded.

Done.

Press H for help.

## Appendix B: Example of a failed getting GPS position

GET NEW GNSS DATA.

NBIIoT module power: ACTIVE

NBIIoT module booting... done.

AT

OK

AT+CFUN=0

OK

AT+CFUN?

+CFUN: 0

OK

AT+GNSSNMEA=0,1000,0,3

OK

AT+GNSSSTART=0

OK

+GNSSEV: 0,1

+GNSSEV: 1,1

GNSS Enabled.

+GNSSEV: 3,0

The Searching of a GNSS position is starting and takes time up to 3 minutes (ESC - stop).

The Searching is in process.

AT+GNSSNMEA=4

CONNECT

.....  
.....

Timeout!

The GNSS module has not received any valid data!

<<< CLOSING MODE >>>

AT+GNSSSTOP

OK

+GNSSEV: 2,1

GNSS Disabled.

AT+CFUN=1

OK

AT+CFUN?

+CFUN: 1

OK

Done.

<<< Module Power OFF process >>>

AT

OK

AT+CPOF

OK

NB IoT module power: SLEEP

Press H for help.

The weather station did not find any GPS signal from the satellites.

## Appendix C: Example of an unsuccessful communication

In this example we can see what happens when the weather station successfully joined the network, it successfully transmitted the sensor data to the network but it did not get any response from the FieldClimate cloud.

In this situation we advise to test the communication again and if it fails, the next step is to check with the mobile network provider if our default IP and port are blocked on their network.

SENSOR DATA TRANSMISSION.

NB IoT module power: ACTIVE

NB IoT module booting... done.

AT

OK

AT+CFUN?

+CFUN: 0

OK

AT+CFUN?

+CFUN: 0

OK

AT+CFUN?

+CFUN: 0

OK

AT+CFUN?

+CFUN: 1

OK

AT+KSIMSEL?

+KSIMSEL: 0,,1

OK

AT&K3

OK

ATS2=255

OK



ATI0

HL7802

OK

ATI8

HL7802.4.6.8

OK

ATI3

HL7802.4.6.8.0

OK

AT+GSM

354616091164660

OK

AT+KGSN=3

+KGSN: 5N045586581410

OK

AT+CCID

+CCID: 89882390000123427554

OK

AT+CIMI

901288003969214

OK

AT+KSRAT?

+KSRAT: 1

OK

<<< NB1 network selected >>>

AT+CGDCONT?

+CGDCONT: 1,"IP",,,0,0,0,0,0,,0,,,,,

OK

AT+COPS?

+COPS: 0

OK

AT+CEREG?

+CEREG: 0,2

OK

AT+CEREG?

+CEREG: 0,2

OK

AT+CEREG?

+CEREG: 0,2

OK

AT+CEREG?

+CEREG: 0,2

OK

AT+CEREG?

+CEREG: 0,2

OK

AT+CEREG?

+CEREG: 0,2

OK

AT+CEREG?

+CEREG: 0,2

OK

AT+CEREG?

+CEREG: 0,2

OK

AT+CEREG?

+CEREG: 0,2

OK

AT+CEREG?

+CEREG: 0,5

OK

<<< Registered in 10 seconds, roaming >>>

AT+COPS?

+COPS: 0,0,"DATA ONLY",9

OK

AT+CGDCONT?

+CGDCONT: 1,"IP",,,0,0,0,0,0,,0,,,,,

OK

AT+CGPADDR=1

+CGPADDR: 1,"100.93.238.95"

OK

AT+KCNXCFG=1,"GPRS", ""

OK

AT+KCNXUP=1

OK

+KCNX\_IND: 1,1,0

AT+KUDPCFG=1,0

+KUDPCFG: 1

OK

+KUDP\_IND: 1,1

<<< Joined >>>

AT+KUDPSND=1,"80.122.185.10", "33332", 428

CONNECT

W0sEAgABwM/AAzEAAZABAIwBBC0FIQUIAAECEAURREFUQSBPTkxZABIKABQJAAAAFXaTAwAWAQZOb251AAOb251AAh0b251AAkBCKhMNzgwMAALSEw30DAwLjQuNi44AAxITDc4MDAuNC42LjguMAANMzU0NjE2MDkxMTY0NjYwAA440Tg4MjM5MDAwMDEyMzQyNzU1NAAPOTAxMjg4MDAzOTY5MjE0ABNnABcAAAAAGCwBGYQDgGgHG/AAHDVOMDQ1NTg2NTgxND EwAB0yOS0wNDA5AA==

yTUFAGeBwM/AAzEAIQYBADARAAAAAAcAAWEZHgACpxo=

SicGAGeBwM/AAzEAIQYBAEURAAAAAAcAATAZHgAC0ho=

u9UHAgeBwM/AAzEAIQYBAAASAAAAAAcAATUZHgAC4ho=

--EOF--Pattern--

OK

<<< Response timeout >>>

<<< No data to download through UDP connection >>>

<<< CLOSING MODE >>>

AT+KUDPCLOSE=1

OK

AT+KCNXDOWN=1,1

OK

+KCNX\_IND: 1,3

AT+KSRAT?

+KSRAT: 1

OK

AT+CESQ

+CESQ: 99,99,255,255,21,39

OK

<<<Checking FOTA update >>>

AT+KSRAT?

+KSRAT: 1

OK

FOTA not supported for this RAT

<<< Module Power OFF process >>>

AT

OK

AT+CPOF

OK

NB-IoT module power: SLEEP

ERROR: NB-IoT communication failure!